

STANDARD RECOVERY DIODES

Stud Version

Features

- High current carrying capability
- High surge current capability
- Types up to 1200V V_{RRM}
- Stud cathode and stud anode version
- Standard JEDEC types
- Diffused junction

300A

Typical Applications

- Battery chargers
- Converters
- Power supplies
- Machine tool controls

Major Ratings and Characteristics

Parameters	300HF(R)	Units
$I_{F(AV)}$	300	A
@ T_C	125	°C
$I_{F(RMS)}$	470	A
I_{FSM} @ 50Hz	5000	A
@ 60Hz	5200	A
I^2t @ 50Hz	125	KA ² s
@ 60Hz	113	KA ² s
V_{RRM} range	400 to 1200	V
T_J	-40 to 180	°C

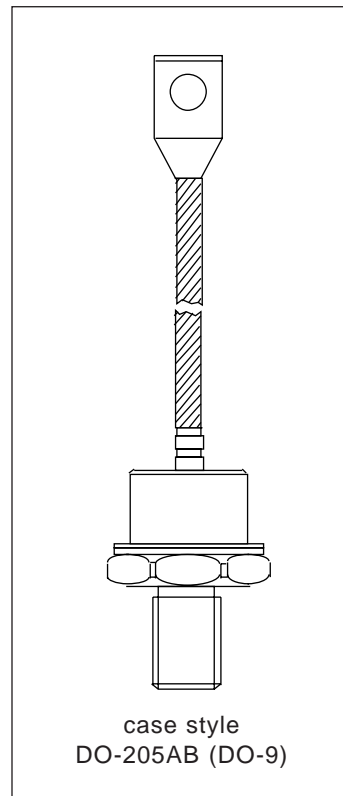

300HF(R) Series

Bulletin I2021 rev. A 07/94

International
 Rectifier

ELECTRICAL SPECIFICATIONS

Voltage Ratings

Type number	Voltage Code	V_{RRM} , maximum repetitive peak voltage V	V_{RSM} , maximum non-repetitive peak voltage V	I_{RRM} max. @ 180°C mA
300HF(R)	40	400	500	20
	80	800	900	
	120	1200	1300	

Forward Conduction

Parameter	300HF(R)	Units	Conditions
$I_{F(AV)}$ Max. average forward current @ Case temperature	300	A	180° conduction, half sine wave
	125	°C	
$I_{F(RMS)}$ Max. RMS forward current	470	A	DC @ 118°C case temperature
I_{FSM} Max. peak, one-cycle forward, non-repetitive surge current	5000	A	t = 10ms No voltage reappplied
	5200		t = 8.3ms reappplied
	3800		t = 10ms 100% V_{RRM} reappplied
	4000		t = 8.3ms reappplied
I^2t Maximum I^2t for fusing	125	KA ² s	t = 10ms No voltage reappplied
	113		t = 8.3ms reappplied
	72		t = 10ms 100% V_{RRM} reappplied
	66		t = 8.3ms reappplied
$I^2\sqrt{t}$ Maximum $I^2\sqrt{t}$ for fusing	1250	KA ² /s	t = 0.1 to 10ms, no voltage reappplied
$V_{F(TO)1}$ Low level value of threshold voltage	0.86	V	$(16.7\% \times \pi \times I_{F(AV)} < I < \pi \times I_{F(AV)})$, $T_J = T_J \text{ max.}$
$V_{F(TO)2}$ High level value of threshold voltage	0.89		$(I > \pi \times I_{F(AV)})$, $T_J = T_J \text{ max.}$
r_{f1} Low level value of forward slope resistance	0.48	mΩ	$(16.7\% \times \pi \times I_{F(AV)} < I < \pi \times I_{F(AV)})$, $T_J = T_J \text{ max.}$
r_{f2} High level value of forward slope resistance	0.46		$(I > \pi \times I_{F(AV)})$, $T_J = T_J \text{ max.}$
V_{FM} Max. forward voltage drop	1.38	V	$I_{FM} = \pi \times I_{F(AV)}$, $T_J = 25^\circ\text{C}$, $t_p = 10\text{ms}$ sinusoidal wave

Thermal and Mechanical Specification

Parameter	300HF(R)	Units	Conditions
T _J Max. operating temperature range	-40 to 180	°C	
T _{stg} Max. storage temperature range	-55 to 180		
R _{thJC} Max. thermal resistance, junction to case	0.12	K/W	DC operation
R _{thCS} Max. thermal resistance, case to heatsink	0.05		Mounting surface, smooth, flat and greased
T Max. allowed mounting torque +0 -20%	28	Nm	Not lubricated threads
	22		Lubricated threads
wt Approximate weight	250	g	
Case style	DO-205AB(DO-9)		See Outline Table

ΔR_{thJC} Conduction

(The following table shows the increment of thermal resistance R_{thJC} when devices operate at different conduction angles than DC)

Conduction angle	Sinusoidal conduction	Rectangular conduction	Units	Conditions
180°	0.030	0.022	K/W	T _J = T _J max.
120°	0.035	0.037		
90°	0.045	0.048		
60°	0.064	0.066		
30°	0.104	0.105		

Ordering Information Table

Device Code

300	HF	R	120	P	B
①	②	③	④	⑤	⑥

- 1** - Essential Part Number
- 2** - Diode
- 3** - None = Stud Normal Polarity (Cathode to Stud)
R = Stud Reverse Polarity (Anode to Stud)
- 4** - Voltage code: Code x 10 = V_{RRM} (See Voltage Ratings table)
- 5** - P = Stud base DO-205AB(DO-9) 3/4" 16UNF-2A
M = Stud base DO-205AB(DO-9) M16 x 1.5
- 6** - B = Flag top terminals (for Cathode/ Anode Leads)
S = Isolated lead with silicone sleeve
(Red = Reverse Polarity; Blue = Normal Polarity)
None = Not isolated lead

300HF(R) Series

Bulletin I2021 rev. A 07/94

Outline Table

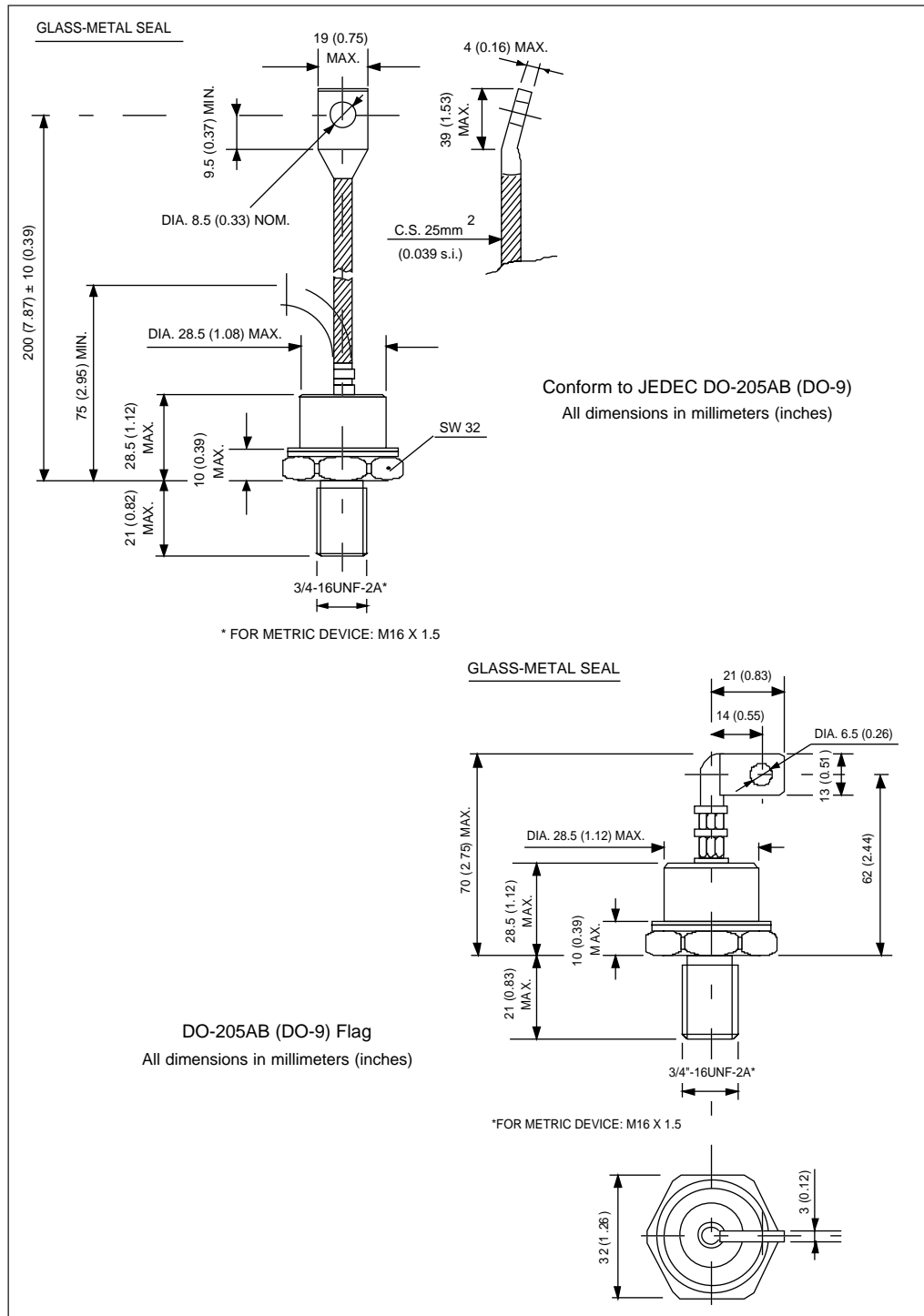

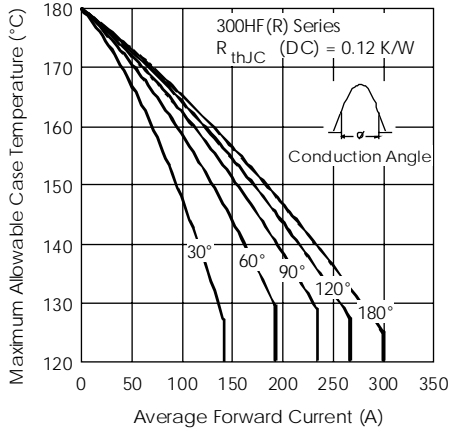

Fig. 1 - Current Ratings Characteristics

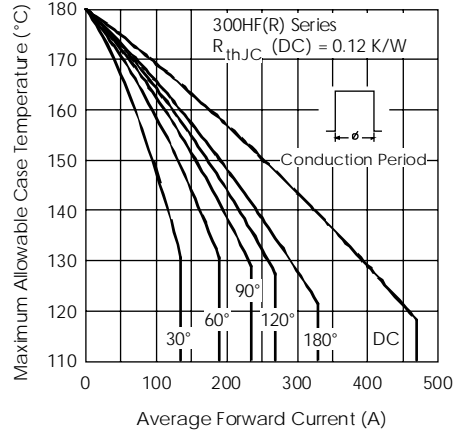

Fig. 2 - Current Ratings Characteristics

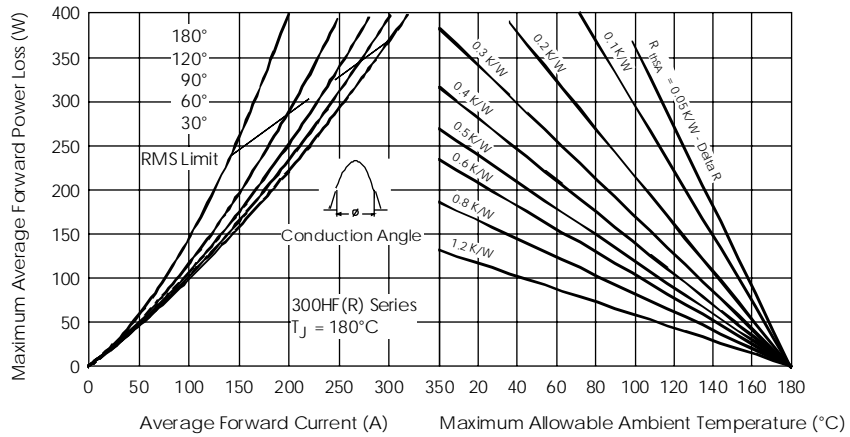

Fig. 3 - Forward Power Loss Characteristics

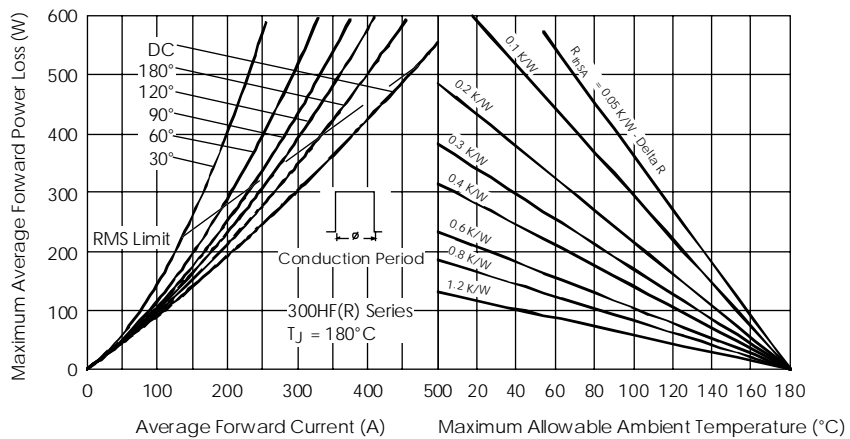

Fig. 4 - Forward Power Loss Characteristics

300HF(R) Series

Bulletin I2021 rev. A 07/94

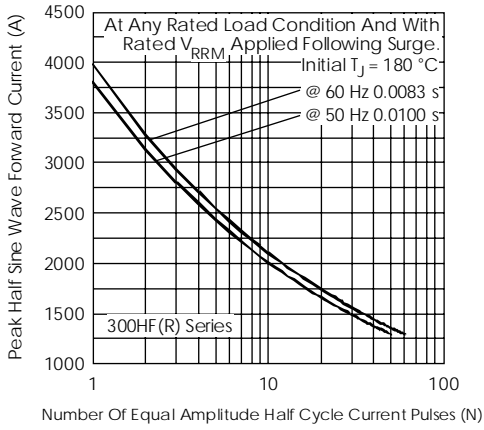

Fig. 5 - Maximum Non-Repetitive Surge Current

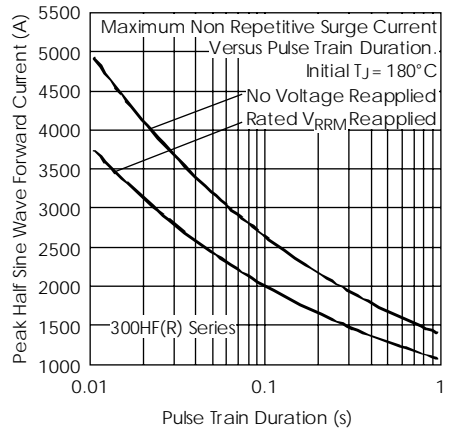

Fig. 6 - Maximum Non-Repetitive Surge Current

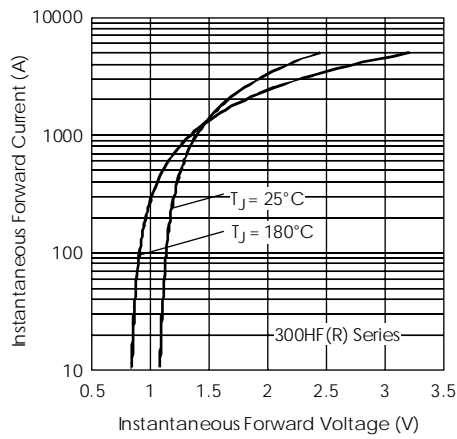

Fig. 7 - Forward Voltage Drop Characteristics

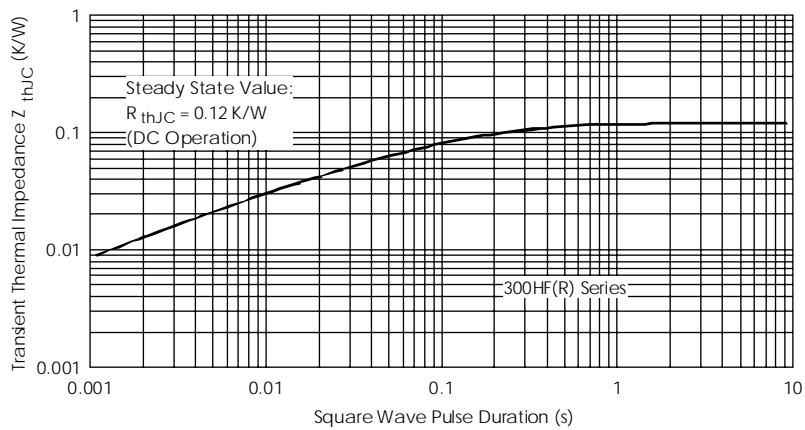

Fig. 8 - Thermal Impedance Z_{thJC} Characteristic